



InjectorDosPro



Operator's Manual

Publication Part No: 9654

Revision: 4

Edition Notice

Prepared and printed by or on behalf of:



This publication covers the following products:

InjectorDos Pro

This document is prepared for Micron Sprayers Ltd. their agents and clients. The document should be taken in its entirety. No responsibility can be accepted, nor can consent be assumed for the part reproduction, editing, extract or quotation taken out of context of this document.

All rights reserved. No part of this publication may be reproduced, stored in a retrieval system, or transmitted in any form or by any means, electronic, mechanical, photocopying, recording or otherwise, without the prior permission of Micron Sprayers Ltd.

Copyright © Micron Sprayers Ltd. 2023

Whilst every effort has been made to ensure the accuracy of this document, any errors or inaccuracies should be reported to Micron Group or their agents.



Porthouse Industrial Estate

Bromyard,

Herefordshire.

HR7 4HS

U.K.

T +44 (0)1885 482397 F +44 (0)1885 483043

E enquiries@micron.co.uk

www.micron.co.uk

Preface

This document has been produced to provide guidance in the installation and use of the InjectorDos Pro and associated accessories.

Operators of the InjectorDos Pro should read this document thoroughly. Operators **must** understand the correct use of this equipment and necessary safety precautions before attempting to install or operate the InjectorDos Pro or its associated accessories.

Readers should pay particular attention to the '**Important Information**' section of this document.

Please contact Micron Group or their agents if you require any assistance.

While reading this document please be aware of the following conventions:

Bold text has been used to highlight information of particular interest.

Italic text has been used to signify references, quoted text and text that provides additional information to the reader. This text may also be highlighted by the use of bold text.

For further information on the use of markers and symbols please refer to the '**Important Information**' section of this document.

Micron Group is the registered trademark of, Micron Sprayers Limited, Bromyard, Herefordshire, United Kingdom. All other trademarks used in this Handbook are the property of their respective owners.

Every care has been taken in the design of this equipment and the preparation of this Handbook. However, Micron Sprayers Limited cannot accept responsibility for errors or the consequences thereof.

The user must satisfy themselves that the equipment is suited to the intended use, is functioning correctly and its use is in compliance with local regulations controlling the application of pesticides.

All spray applications illustrated in this Handbook are provided for guidance only. Users should always refer to the product label when using pesticides for specific conditions of use.

IMPORTANT INFORMATION (PLEASE READ)

Instruction to operators

The equipment referred to in this document is designed for use by suitably qualified and experienced personnel. The user **must** ensure that they are fully compliant with any national or local regulations governing the use of pesticides and application equipment before attempting to use the InjectorDos Pro. If miss-used the InjectorDos Pro has the potential to cause harm to personnel or damage to the equipment, property or the environment. Please read the information in this guide thoroughly before installing and/or operating the equipment.

This document is not intended to contravene or supersede any national or international operating or safety standards. Where other national or international standards are available the higher standards should be used.

It is the operator's responsibility to ensure the safe use of the equipment and the safety of others during use of the equipment.



It is the operator's responsibility to minimise environmental impact from the use of the equipment.















It is the operator's responsibility to ensure that all warning labels on the machine are legible. Any damaged labels must be replaced.

Working with this document

This document has been written to provide the information to correctly install and use the equipment safely. Various symbols are used on the equipment and in this document to provide guidance to the operator; please take time to become familiar with these symbols.

Symbols used on the equipment and in this document

	Denotes a caution or warning – ‘things you should be aware of’ . A specific warning is given in or close to this symbol. NEGLIGENCE OF THIS MAY CAUSE THE DEATH OR SERIOUS INJURY OF A PERSON OR SERIOUS DAMAGE TO THE EQUIPMENT OR ENVIRONMENT.
	Denotes a mandatory prohibition – ‘things you must not do’ . A specific prohibition is given in or close to this symbol.
	Denotes a mandatory instruction – ‘things you must do’ . A specific instruction is given in or close to this symbol
NEGLIGENCE OF ANY STATED WARNING, PROHIBITION OR MANDATORY INSTRUCTION MAY CAUSE THE DEATH OR SERIOUS INJURY OF A PERSON OR SERIOUS DAMAGE TO THE EQUIPMENT OR ENVIRONMENT.	

	Mandatory Prohibition		Caution or Warning		Mandatory Instruction
	Do not insert fingers or foreign objects		Warning – danger from leaking substances		Refer to Instructions
	STOP - Do not proceed with this action		Wash hands – hands must be washed after handling		Protective Clothing – must be worn
	Face Shield – must be worn		Protective Boots – must be worn		Gloves – must be worn
	Toxic – risk of contact with toxic substances		Harmful – substance is harmful		Danger to the environment – risk of contamination

Prohibitions in Use

The InjectorDos Pro and dual tank system are designed for use with agricultural spray products that are approved for use in the intended crop situation.

The use of non-approved pesticides is strictly prohibited.

The equipment should **not** be used to with the following materials.

- Any form of petrochemical fuel or oil.
- Acids.
- Concentrate solvents.

For lubricating fluids refer to the maintenance section of this document.

Table of Contents

Section		Page
1	INTRODUCTION	9
1.1	SYSTEM FEATURES	9
1.2	TECHNICAL SPECIFICATION	10
2	SAFETY	11
2.1	WORKING WITH PESTICIDES	12
2.1.1	OPERATOR PROTECTION	12
2.1.2	PRODUCT LABELS	13
2.1.3	STORAGE OF PESTICIDES	13
2.2	PROTECTION OF THE ENVIRONMENT	13
3	PREPARING FOR USE	14
4	APPLICATION METHOD	16
5	CLEANING	17
5.1	DISPOSAL OF RINSATE	17
6	MAINTENANCE	18
6.1	TROUBLESHOOTING	18
7	DISPOSAL	19
8	PARTS LIST	20
APPENDIX A -	CONVERSION FACTORS	22

1 INTRODUCTION

Specifically designed for eliminating invasive weeds such as Japanese Knotweed, Giant Hogweed and Horsetail, the InjectorDos Pro provides an effective and safe way to treat weeds in places where spray applicators are unsuitable.

The InjectorDos Pro is a handheld injection applicator with the facility to 'dial-in' a predetermined metered volume of liquid to be dispensed. The InjectorDos Pro is suitable for injecting herbicide into weeds with hollow stems e.g., Japanese Knotweed (*Fallopia Japonica*).

Note. The small Fine needle is used for re-growth only.

The InjectorDos Pro offers a safe and effective means of treating weeds in or next to sensitive areas (e.g., close to waterways) or where adjacent foliage needs to be preserved and a spray is unsuitable.

The InjectorDos Pro comes with a one litre Backpack to replenish the applicator via a length of hose. Liquid supply can be shut off using an in-line tap.

1.1 System Features

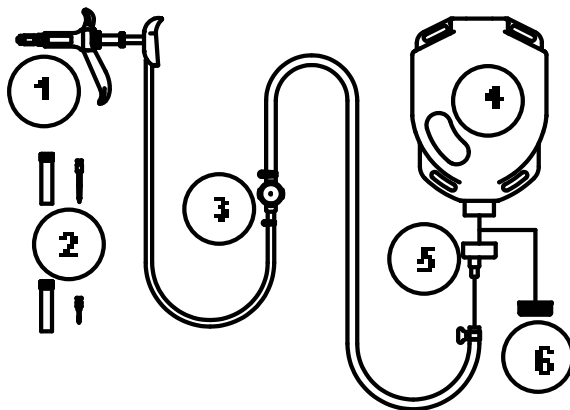







- 1 Injector unit
- 2 Spears (2 sizes)
- 3 In-line tap

- 4 Backpack 1 Litre
- 5 Hose connection cap
- 6 Storage cap

1.2 Technical Specification

InjectorDos Pro	
Product Identification Details	
Trade name:	InjectorDos Pro
Description:	Metered-dose injection applicator for invasive weed control
Model:	InjectorDos Pro
Manufacturer:	Micron Sprayers Ltd.
Weights and Measures	
Net weight:	475 g
Dose range:	0.1– 2.0 ml
Backpack Capacity:	1 Litre
Environmental Conditions	
Minimum working temperature:	+5°C

2 SAFETY

WARNINGS AND PROHIBITIONS	
 	<p>Do not insert fingers or any foreign object into the equipment. This may cause a risk of harm and may damage the equipment.</p> <p>Do not dismantle or modify the equipment. This may cause a risk of harm and may damage the equipment.</p> <p>Do not operate the equipment if there are visible symptoms of a problem, such as leaking fluids, abnormal noise or structural damage. Operating the equipment under such conditions may cause a risk of harm or may damage the equipment or the environment.</p>
	<p>Danger from leaking substances. Substances may be harmful and/or under high pressure.</p>
 	<p>Risk of contact with toxic or hazardous substances.</p> <p>Always read and retain the instructions on chemical used in this equipment.</p> <p>Ensure that all instructions for the chemicals being used remain with the equipment until the equipment has been cleaned and is ready for storage or re-use.</p> <p>Do not drink, eat or smoke when using the equipment or handling pesticides.</p> <p>Do not dispose of toxic or hazardous chemicals or fluids into drains or water courses.</p>
	<p>When connecting or disconnecting hoses to the equipment; always grasp the connector directly, do not hold by or pull on the hose as this may cause damage.</p> <p>Always wear personal protective equipment when instructed.</p>

2.1 Working with Pesticides



Wear
Gloves



Wear Face
Protection



Wear
Protective
Clothing



Wear
Protective
Boots



Wash hands



Always read the product label before preparing spray mixes. Always adhered to recommended spray dose rates, volume rates and safety precautions.



All pesticides **must** be handled and stored in accordance with the manufacturer's instructions.

All pesticides must be stored in their original containers.

Always Dispose of chemicals in accordance with the manufacturer's instructions.



It is the responsibility of the user to ensure all possible measures are taken to protect the environment.

It is the responsibility of the user to be familiar with, and adhere to, all relevant national and local restrictions, prohibitions and regulations concerning use of pesticides.

2.1.1 Operator Protection



Wear
Gloves



Wear Face
Protection



Wear
Protective
Clothing



Wear
Protective
Boots



Wash hands

Operators **MUST** always read the product label **BEFORE** using pesticides. Operators **MUST** adhere to the required use of personal protective equipment (PPE). When handling concentrates operators should wear gloves, coveralls, boots and a face shield to protect eyes and skin from accidental splashes. Some products may also require the use of a respirator mask.

2.1.2 Product Labels



ALWAYS read the product label **BEFORE** using pesticides. **ALWAYS** adhere to the minimum and maximum dose rates, recommended mixing rates and any precautions regarding protection of the operator and environment.

2.1.3 Storage of Pesticides



Always store pesticides away from heat and sunlight in a secure area.

Pesticides Should be stored in their original containers.



2.2 Protection of the Environment



Pesticides should always be disposed of according to manufacturer's recommendation.

Tank washings and rinsate should always be sprayed out onto either the treated crop (taking care not to exceed maximum dose rates) or onto a designated area.



Always avoid run-off into ditches or waterways.

3 PREPARING FOR USE

- Connect the Injector unit to the smaller of the supplied hoses.
- Connect the free end of the hose to the in-line tap. Secure the hose in place with the smaller of the supplied self-tightening hose clips.
- Connect the larger of the supplied hoses to the free end of the tap. Secure the hose in place with the larger of the supplied self-tightening hose clips.
- Attach the supplied strap to the backpack. Pass the strap through the slotted holes in the sequence shown.
- Pass your left arm through the loop created between slots 1 and 2 and your right arm through the loop created between 3 and 4.
- Adjust the strap so that the backpack sits comfortably in the centre of your back.
- Remove the backpack ready for filling.
- Fill the backpack with chemical, generally undiluted product containing 360gl glyphosate e.g., Roundup™
- Screw the supplied hose connector cap onto the backpack.
- Push on the free end of hose and secure it in place with the supplied thumbscrew hose clip.

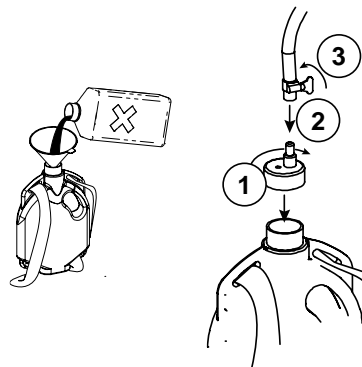
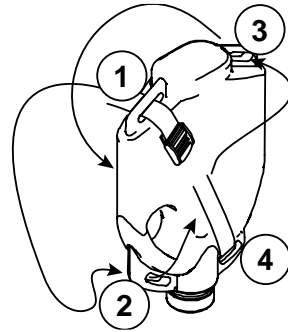
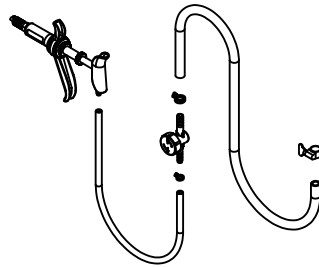

- Open the in-line tap.
- Hold the needle in to a collecting bottle and operate the trigger mechanism on the Injector unit several times.
- The unit will be primed and ready for use when all the air has been expelled from the syringe chamber and feed tube.
- Select the appropriate spear tip. Normal operation will require the use of the larger spear tip. The smaller spear tip is **only** for use on new shoots.
- Unscrew the knurled end of the injector unit until the internal recess is clear of the outlet.
- Slide the spigot at the end of the spear tip into the recess.
- Turn the knurled end clockwise to tighten the spear tip against the outlet.
- Ensure that the spear tip is fitted into the recess and not against the back face of the knurled end. If the spear tip is fitted incorrectly, it may leak or break when used.

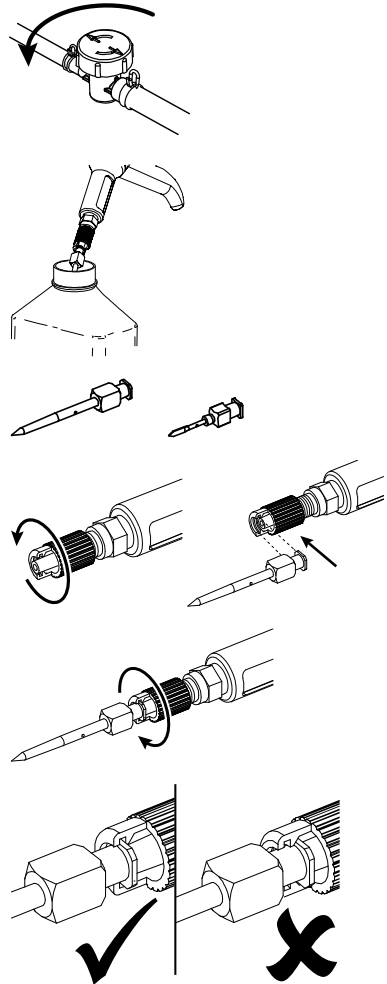

4 APPLICATION METHOD

- Release locknut and adjusting nut behind the main hand grip of the injector unit.
- Adjust the injector unit to the desired injection dose, generally 2 ml; the dose can be measured with the scale on the sight glass.
- Retighten locknut.
- Push the needle fully into the stem to be injected so that the 2 cross holes are inside the stem.
- Ensure that the injector is pushed straight into the stem. **Do Not** lift or push the injector down or sideways when the spear is inserted into the stem as this will bend the spear tip.

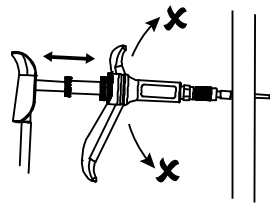
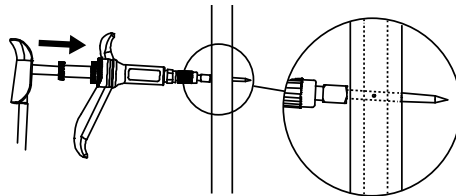
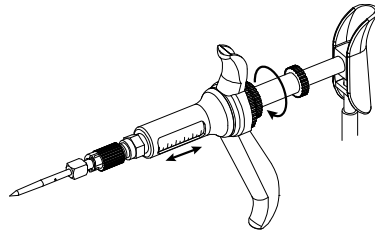

When injecting Japanese Knotweed (*Fallopia Japonica*) injection should take place between the 2nd and 3rd node, generally using a single dose of 2ml of undiluted glyphosate.

NOTE. Never force the Injector syringe if resistance is experienced. Withdraw the needle and check that it is not blocked. Clean if necessary.

5 CLEANING

- Disconnect the injection applicator from the backpack. Open the in-line tap and drain chemical back into the backpack. Store backpack with filling cap uppermost.
- Empty any chemical residue into a suitable container. Use the original chemical container for undiluted products.
- Flush with clean water to remove chemical residue.
- Flush through and clean thoroughly with warm water and detergent.

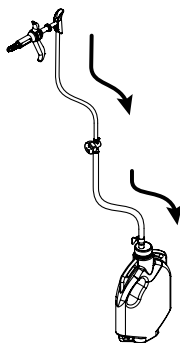

Regular cleaning with warm water and detergent is recommended.

NOTE. When storing for a prolonged period flush the injection applicator through with warm water and detergent and lubricate the 'O' ring with a light oil, refer to the maintenance section of this manual.

Always follow the instructions on the label of the chemical being used.

5.1 Disposal of Rinsate



Remove residues in accordance with the manufacturer's instructions.

Dispose of chemicals in accordance with the manufacturer's instructions.

Harmful chemicals **must** always be handled and stored in accordance with the manufacturer's instructions.

Harmful chemicals **must** be stored in their original containers.



It is the responsibility of the user to ensure all possible measures are taken to protect the environment.

It is the responsibility of the user to be familiar with, and adhere to, all relevant national and local restrictions, prohibitions and regulations.

6 MAINTENANCE

- Clean the injection applicator regularly with warm water and detergent.
- Periodically remove the syringe barrel and lubricate the 'O' ring with a light oil.

A service kit is available from Micron Sprayer Ltd.

PARTS BREAKDOWN

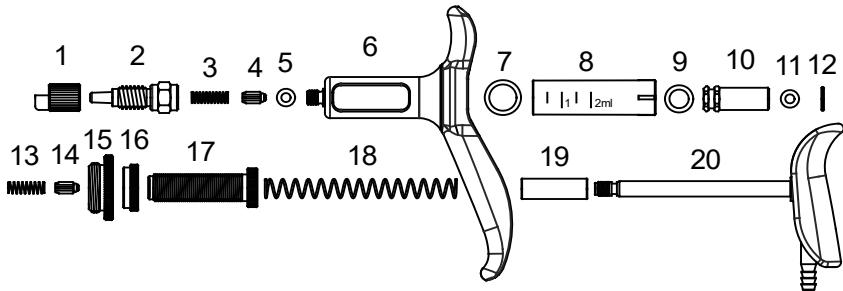

- | | |
|----------------------------|----------------------------|
| 1. Needle Nut | 11. Push Rod Seal Ring* |
| 2. Needle Mount | 12. Piston Collar |
| 3. Delivery Valve Spring* | 13. Inlet Valve Spring* |
| 4. Delivery Valve* | 14. Inlet Valve* |
| 5. Needle Mount Seal Ring* | 15. Back Cap |
| 6. Body | 16. Dose Adjuster Lock Nut |
| 7. Cylinder Seal Ring* | 17. Dose Adjustor |
| 8. Cylinder* | 18. Return Spring* |
| 9. Piston Seal Ring* | 19. Spring Cover |
| 10. Piston | 20. Push Rod |

* Service kit contains items 3, 4, 5, 7, 8, 9, 11, 13, 14, 18.

6.1 Troubleshooting

- If the syringe starts to stick on operation remove the syringe barrel and lubricate the 'O' ring with a light oil.
- If the syringe locks on compression the needle injector may be blocked. Never force the syringe as this can damage the non-return valve. Always remove the needle assembly, check for blockages, clean and ensure free operation of the cylinder.

7 DISPOSAL



It is the responsibility of the user to ensure the disposal of the equipment is in accordance with all national or local restrictions, prohibitions and regulations.

Remove chemical residues in accordance with the manufacturer's instructions.

Dispose of chemicals in accordance with the manufacturer's instructions.

Harmful chemicals **must** always be handled and stored in accordance with the manufacturer's instructions.



Harmful chemicals **must** be stored in their original containers.

It is the responsibility of the user to ensure all possible measures are taken to protect the environment.

It is the responsibility of the user to be familiar with, and adhere to, all relevant national and local restrictions, prohibitions and regulations.

To dispose of the equipment, reduce the equipment to its component parts. Thoroughly clean all component parts inside and out.

Dispose of the component parts by material and type in accordance with all national and local restrictions, prohibitions and regulations.

8 PARTS LIST

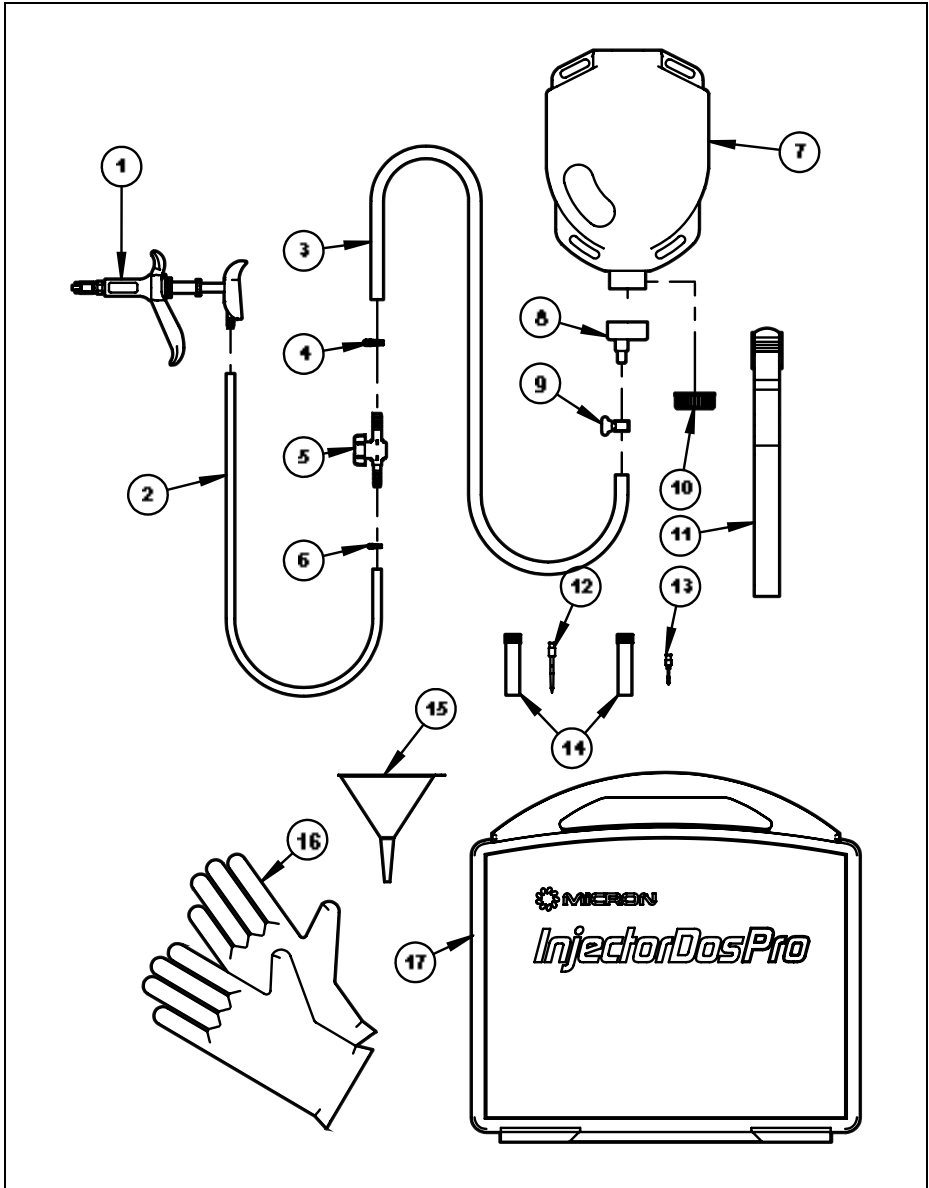

Injectordos Pro, Standard Components

Parts List – Injectordos Pro

ITEM	PART NO.	DESCRIPTION	QTY.
1	8036	INJECTOR, 2ml (INJECTORDOS PRO)	1
-	9078	SERVICE KIT, INJECTORDOS PRO	-
2	4309	TUBE, 5 mm ID X 8 mm OD - PER M CLEAR UNREINFORCED PVC	0.5 m
3	5414	TUBE, 8 mm ID X 12 mm OD - 0.90M CLEAR UNREINFORCED PVC	0.9 m
4	6029	CLIP, 11.9 mm, HOSE, SELF TIGHTENING	1
5	11909	TAP	1
6	6028	CLIP, 9.1 mm, HOSE, SELF TIGHTENING	1
7	7665	BACKPACK, 1 LITRE	1
8	7664	CAP, 38 mm VENTED DUAL SPIGOT WITH DUCKBILL VALVE	1
9	5464	CLIP, HOSE, NO 12, WINGSCREW	1
10	9556	CAP, 38 mm, C/W WAD	1
11	7666	BACKPACK STRAP (FOR 7665)	1
12	8032	SPEAR, STANDARD (INJECTORDOS)	1
13	8033	SPEAR, FINE (INJECTORDOS)	1
14	9592	CONTAINER, INJECTORDOS SPEARS	2
15	5843	FUNNEL, 100mm DIAMETER, POLYPROPYLENE	1
16	9624	GLOVES, UNLINED, SIZE 9	1
17	9610	CASE, INJECTORDOS PRO KIT	1

Appendix A - Conversion Factors

1 yard	= 3 feet	= 0.91 metre
1 metre	= 39.37 inches	= 1.09 yards
1 statute mile	= 0.87 nautical mile	= 1.61 kilometres
1 nautical mile	= 1.15 statute mile	= 1.85 kilometres
1 kilometre	= 0.62 statute mile	= 0.54 nautical mile
1 statute mile	= 1760 yards	= 5280 feet
1 nautical mile	= 2027 yards	= 6081 feet
1 kilometre	= 1094 yards	= 3282 feet
1 metre/sec	= 2.237 miles per hr	= 196.9 ft/min
1 acre	= 43560 sq feet	= 4840 sq yards
1 acre	= 4047 sq metres	= 0.40 hectare
1 hectare	= 107600 sq feet	= 11955 sq yards
1 hectare	= 10000 sq metres	= 2.47 acres
1 sq mile	= 640 acres	= 259 hectares
1 sq kilometre	= 247 acres	= 100 hectares
1 US gal	= 0.83 Imp gal	= 3.78 litres
1 Imp gal	= 1.20 US gals	= 4.54 litres
1 litre	= 0.26 US gal	= 0.22 Imp gal
1 US pint	= 16 US fl ounces	= 0.47 litres
1 Imp pint	= 20 Imp fl ounces	= 0.57 litre
1 US gal/acre	= 8 US pint/acre	= 9.45 litres/hectare
1 Imp gal/acre	= 8 Imp pints/acre	= 11.35 litres/hectare
1 litre/hectare	= 0.11 US gal/acre	= 0.081 Imp gal/acre
1 pound	= 16 ounces	= 0.45 kilogram
1 kilogram	= 2.20 pounds	= 35.3 ounces
1 ounce	= 28.35 grams	
1 pound/sq inch	= 0.068 atmosphere	= 0.067 bar
1 atmosphere	= 14.70 pounds/sq in	= 1.01 bar
1 bar	= 14.50 pounds/sq in	= 0.98 atmosphere
1 kilopascal	= 0.01 bar	= 0.145 pounds/sq in

Index

APPLICATION METHOD	16	PESTICIDES	12
BOLD TEXT	4	PREPARING FOR USE	14
CLEANING	17	PREPARING FOR USE	14
CONVERSION FACTORS	22	PROHIBITED CHEMICAL	7
COPYRIGHT	3	PROHIBITIONS	7
COUPLING	18	RINSATE	17
DISPOSAL	19	RINSING	17
EDITION NOTICE	3	SAFETY	11
ENVIRONMENTAL PROTECTION	13	SPECIFICATION	10
FEATURES	9	SYMBOLS	6
ITALIC TEXT	4	TABLE OF CONTENTS	8
MICRON GROUP	4	TECHNICAL SPECIFICATION	10
MICRON GROUP ADDRESS	28	TROUBLESHOOTING	18
OPERATING INSTRUCTIONS	14	UNCOUPLING	18
OPERATOR PROTECTION	12	WARNINGS	11
PARTS LIST	20		

Notes

Notes

Notes

Copyright © Micron Sprayers Ltd. 2023

General Enquiries:

Micron Sprayers Ltd.
Porthouse Industrial Estate,
Bromyard, Herefordshire,
HR7 4HS, U.K.

T +44 (0)1885 482397

F +44 (0)1885 483043

E enquiries@micron.co.uk

Goizper Group
Antigua, 4
20577 Antzuola
Gipuzkoa - Spain
T + 34 943 786 000

E goizper@goizper.com

www.micron.co.uk

